

描述 / Descriptions

表面贴装肖特基二极管，反向电压：100V，正向电流：3.0A，薄型 SMBF 封装。
Surface Mount Schottky Barrier Rectifier, Reverse Voltage:100V,Forward Current:3.0A,SMBF thin package.

特征 / Features

低功耗，高效率，浪涌电流大，适用于低压，高频和极性保护，适用于表面贴装。无卤产品。
Low power loss, high efficiency, High forward surge current capability, For use in low voltage, high frequency inverters, and polarity protection applications,For surface mounted applications.Halogen free product.

用途 / Applications

一般用途。
General purpose.

内部等效电路 / Equivalent Circuit



引脚排列 / Pinning

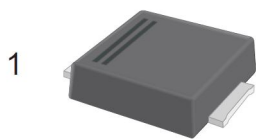

2

PIN	DESCRIPTION
1	Cathode
2	Anode

The recommended mounting pad size

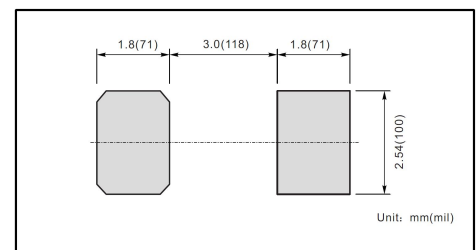

印章代码 / Marking

见印章说明。See Marking Instructions.

极限参数 / Absolute Maximum Ratings(Ta=25°C)

参数 Parameter	参数符号 Symbol	数值 Rating	单位 Unit
Maximum Repetitive Peak Reverse Voltage	V_{RRM}	100	V
Maximum RMS voltage	V_{RMS}	70	V
Maximum DC Blocking Voltage	V_{DC}	100	V
Maximum Average Forward Rectified Current	$I_F (AV)$	3.0	A
Peak Forward Surge Current,8.3ms Single Half Sine-wave Superimposed on Rated Load (JEDEC method)	I_{FSM}	80	A
Typical Junction Capacitance ¹⁾	C_j	160	pF
Typical Thermal Resistance ²⁾	$R_{\theta JA}$	60	°C/W
Operating Junction Temperature Range	T_j	-55~+150	°C
Storage Temperature Range	T_{stg}	-55~+150	°C

Note:

- 1) Measured at 1MHz and applied reverse voltage of 4 V D.C.
- 2) P.C.B. mounted with 2.0 X2.0" (5 X 5 cm) copper pad areas.

电性能参数 / Electrical Characteristics(Ta=25°C)

参数 Parameter	参数符号 Symbol	测试条件 Test condition	数值 Rating	单位 Unit
Max Instantaneous Forward Voltage	V_F	$I_F=3.0A$	0.6	V
Maximum DC Reverse Current at Rated DC Reverse Voltage	I_R	$T_a=25^\circ C$ $T_a=100^\circ C$	1.0 5	mA

电参数曲线图 / Electrical Characteristic Curve

Fig.1 Forward Current Derating Curve

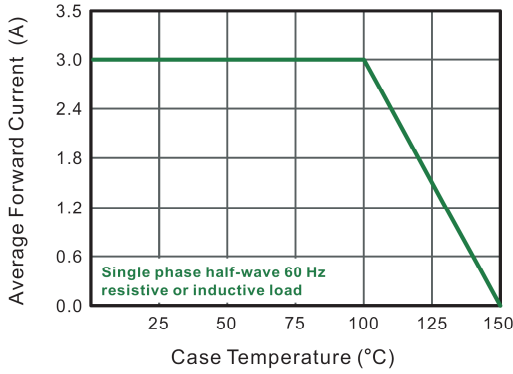

Fig.2 Typical Reverse Characteristics

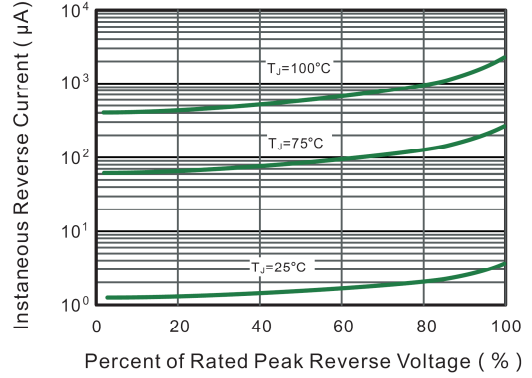

Fig.3 Typical Forward Characteristic

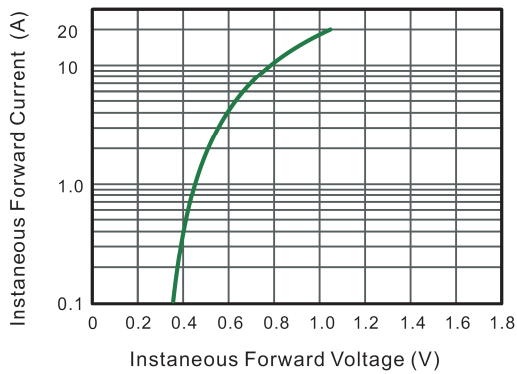

Fig.4 Typical Junction Capacitance

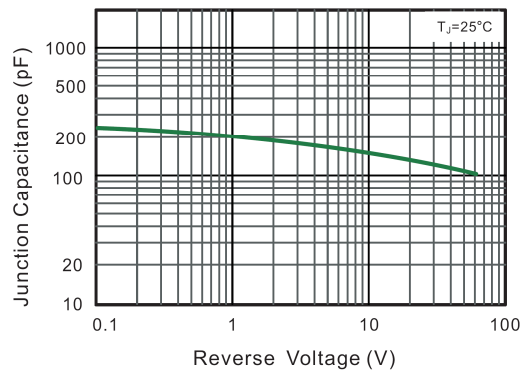

Fig.5 Maximum Non-Repetitive Peak Forward Surge Current

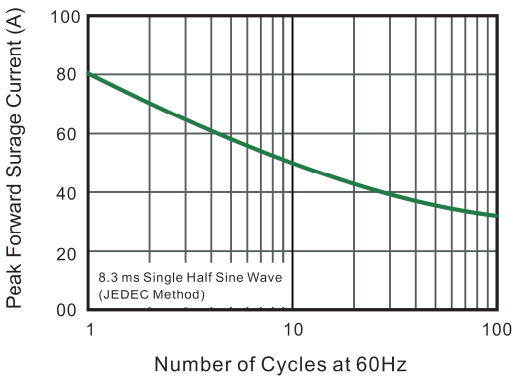
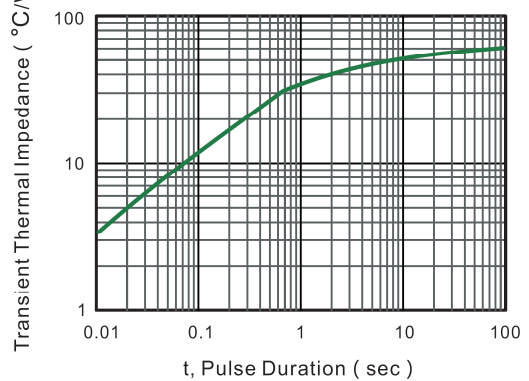
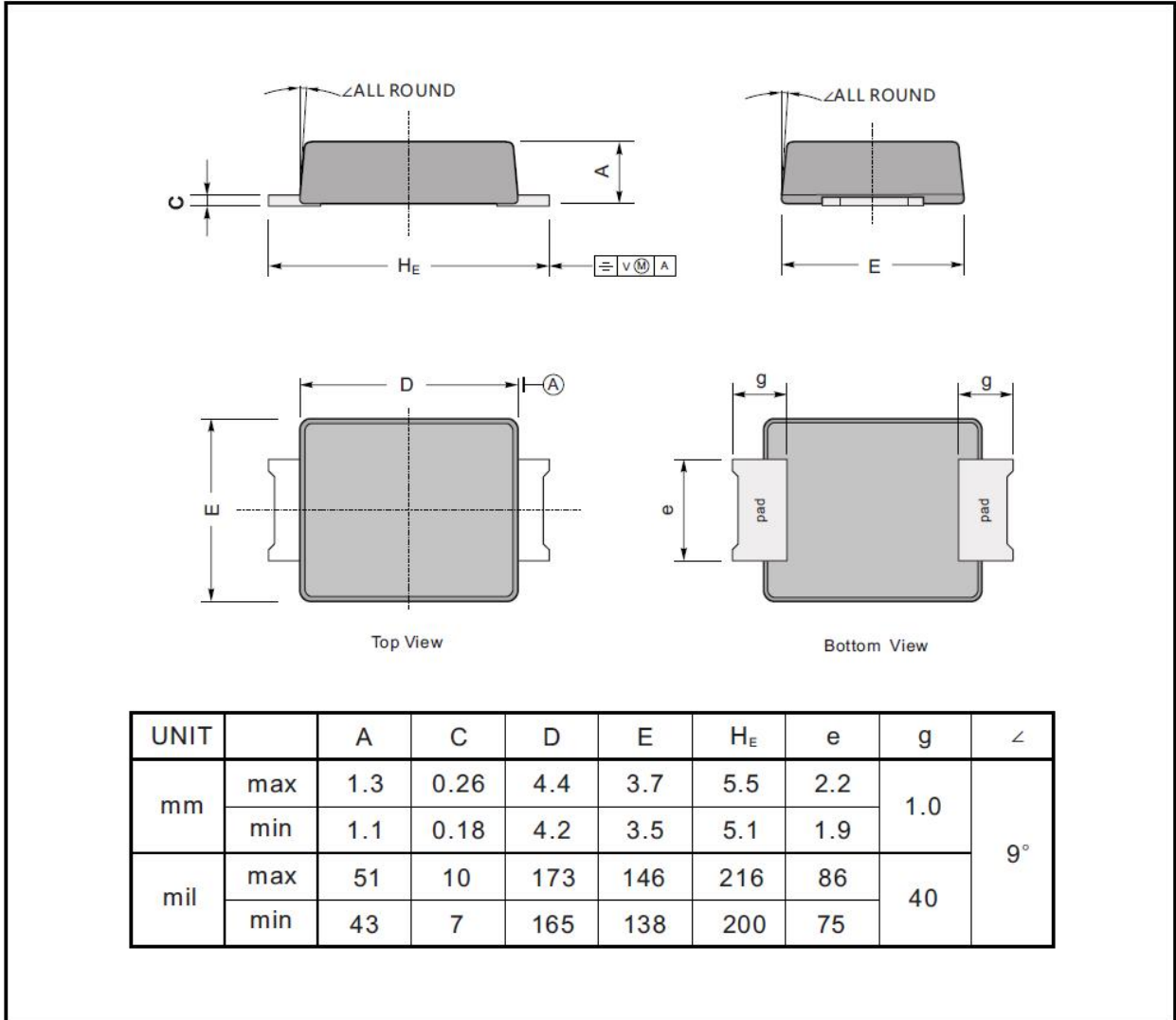

Fig.5- Typical Transient Thermal Impedance



外形尺寸图 / Package Dimensions

SMBF



印章说明 / Marking Instructions

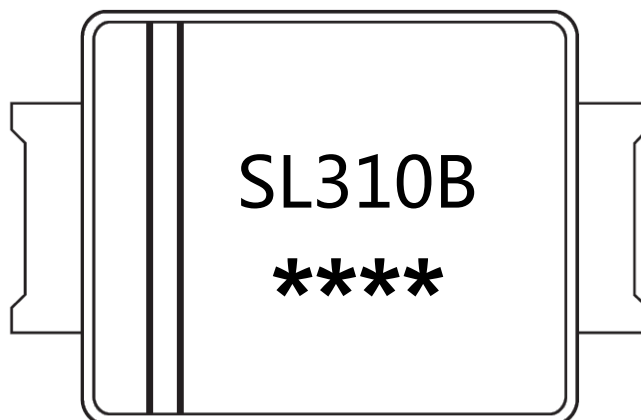

说明：

SL310B： 为型号代码

****： 为生产批号追溯码，第1个*为年月代码，后面3个*为当月小批号代码

Note:

SL310B： Product Type Code

****： Lot No. Code，The 1st * means:YM Code，The last 3 * means:little Lot No Code

回流焊温度曲线图(无铅) / Temperature Profile for IR Reflow Soldering(Pb-Free)

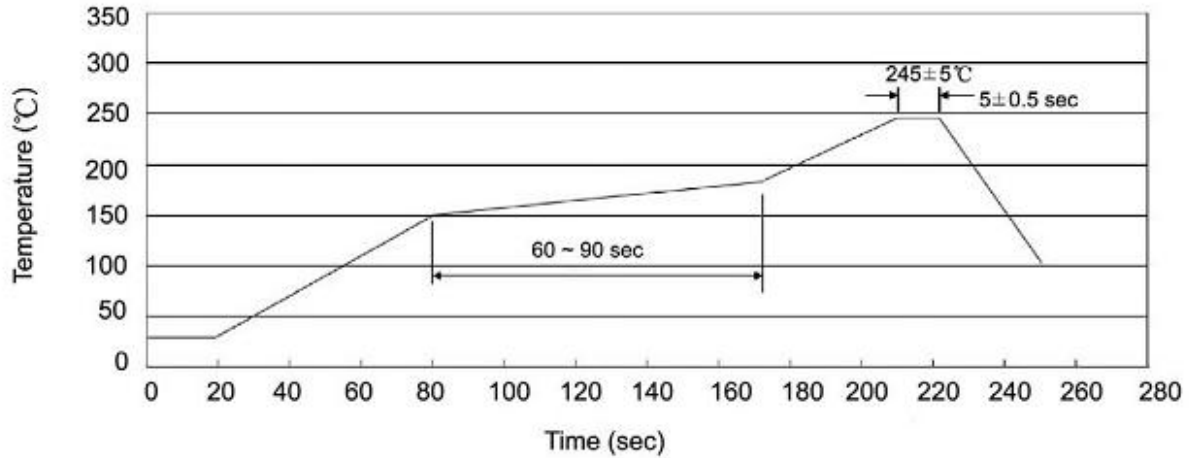

说明：

- 1、预热温度 150 ~ 180°C，时间 60 ~ 90sec;
- 2、峰值温度 245±5°C，时间持续为 5±0.5sec;
- 3、焊接制程冷却速度为 2 ~ 10°C/sec.

Note:

- 1.Preheating:150~180°C, Time:60~90sec.
- 2.Peak Temp.:245±5°C, Duration:5±0.5sec.
3. Cooling Speed: 2~10°C/sec.

耐焊接热试验条件 / Resistance to Soldering Heat Test Conditions

温度：260±5°C

时间：10±1 sec.

Temp.:260±5°C

Time:10±1 sec

包装规格 / Packaging SPEC.

卷盘包装 / REEL

Package Type 封装形式	Units 包装数量					Dimension 包装尺寸 (unit: mm ³)		
	Units/Reel 只/卷盘	Reels/Inner Box 卷盘/盒	Units/Inner Box 只/盒	Inner Boxes/Outer Box 盒/箱	Units/Outer Box 只/箱	Reel	Inner Box 盒	Outer Box 箱
SMBF	5000	2	10000	5	50000	13" ×12	336X332X40	380X335X366

使用说明 / Notices