

BRCS900N10SYM

Rev.C Feb.-2023

描述 / Descriptions

PDFN5×6A 塑封封装双 N 沟道场效应管。

Dual N-CHANNEL MOSFET in a PDFN5×6A Plastic Package.

特征 / Features

Dual N-Ch

VDS(V)=100V

ID=13.7A

RDS(ON)<90mΩ(VGS=10V)

RDS(ON)<130mΩ(VGS=4.5V)

无卤产品。HF Product.

用途 / Applications

PWM 应用、负载开关、电源管理、LED 调光。

PWM Application, Load Switch, Power Management, Dimming LED.

内部等效电路 / Equivalent Circuit

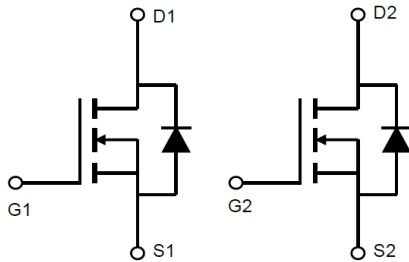

引脚排列 / Pinning

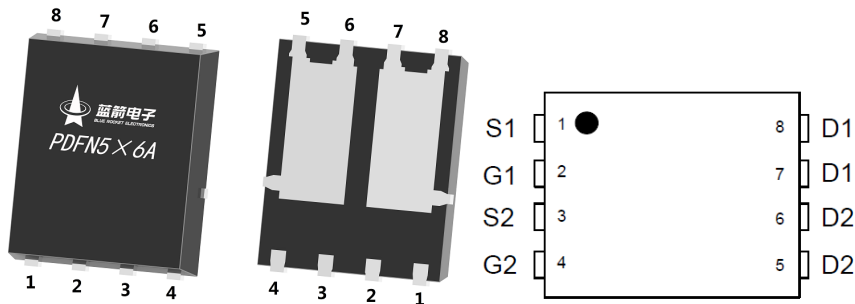

印章代码 / Marking

见印章说明。See Marking Instructions.

极限参数 / Absolute Maximum Ratings($T_a=25^{\circ}\text{C}$)

参数 Parameter	符号 Symbol	数值 Rating	单位 Unit
Drain-Source Voltage	V_{DS}	100	V
Continuous Drain Current	I_D	13.7	A
Pulsed Drain Current	I_{DM}	48	A
Gate-Source Voltage	V_{GS}	± 20	V
Power Dissipation	$P_D(T_c=25^{\circ}\text{C})$	35.7	W
Avalanche energy(L=0.5mH)	E_{AS}	2.7	mJ
Avalanche Current(L=0.5mH)	I_{AS}	3.3	A
Junction and Storage Temperature Range	T_j, T_{stg}	-55 to 150	$^{\circ}\text{C}$
Maximum Junction-to-Ambient	$t \leq 10\text{s}$	$R_{\theta JA}$	$^{\circ}\text{C/W}$
	Steady-State		
Maximum Junction-to-Case	Steady-State	$R_{\theta JC}$	3.5

电性能参数 / Electrical Characteristics($T_a=25^{\circ}\text{C}$)

参数 Parameter	符号 Symbol	测试条件 Test Conditions	最小值 Min	典型值 Typ	最大值 Max	单位 Unit
Drain-Source Breakdown Voltage	BV_{DSS}	$I_D=250\mu\text{A}, V_{GS}=0\text{V}$	100			V
Zero Gate Voltage Drain Current	I_{DSS}	$V_{DS}=100, V_{GS}=0\text{V}$			1.0	μA
Gate-Body leakage current	I_{GSS}	$V_{DS}=0\text{V}, V_{GS}=\pm 20\text{V}$			± 100	nA
Gate Threshold Voltage	$V_{GS(th)}$	$V_{DS}=V_{GS}, I_D=250\mu\text{A}$	1	1.4	2.5	V
Static Drain-Source On-Resistance	$R_{DS(on)}$	$V_{GS}=10\text{V}, I_D=20\text{A}$		68	90	m Ω
		$V_{GS}=4.5\text{V}, I_D=10\text{A}$		84	130	
Diode Forward Voltage	V_{SD}	$I_S=1\text{A}, V_{GS}=0\text{V}$			1.2	V
Input Capacitance	C_{iss}	$V_{DS}=25\text{V}, V_{GS}=0\text{V}, f=1.0\text{MHz}$		180		pF
Output Capacitance	C_{oss}			105		
Reverse Transfer Capacitance	C_{rss}			15		
Gate resistance	R_g	$V_{GS}=0\text{V}, V_{DS}=0\text{V}, f=1\text{MHz}$		1.5		Ω
Total Gate Charge	$Q_{g(10V)}$	$V_{GS}=10\text{V}, V_{DS}=50\text{V}, I_D=5\text{A}$		6.5		nC
Total Gate Charge	$Q_{g(4.5V)}$			3		
Gate Source Charge	Q_{gs}			1.5		
Gate Drain Charge	Q_{gd}			1.5		

电性能参数 / Electrical Characteristics(Ta=25°C)

参数 Parameter	符号 Symbol	测试条件 Test Conditions	最小值 Min	典型值 Typ	最大值 Max	单位 Unit
Turn-On Delay Time	$t_{d(on)}$	$V_{GS}=10V$ $V_{DS}=50V$ $R_L=10\ \Omega$ $R_{GEN}=3\ \Omega$		4		ns
Turn-On Rise Time	t_r			2		
Turn-Off Delay Time	$t_{d(off)}$			15		
Turn-Off Fall Time	t_f			2		

电参数曲线图 / Electrical Characteristic Curve

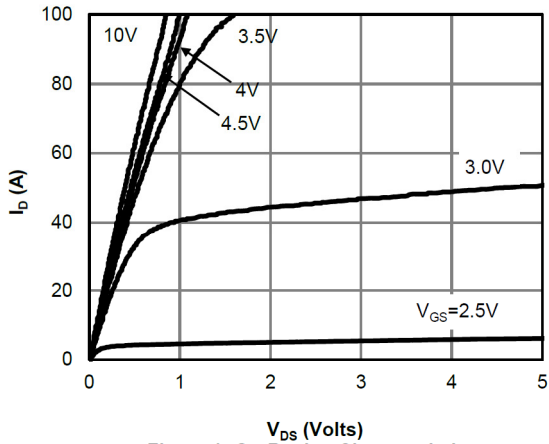

Figure 1: On-Region Characteristics

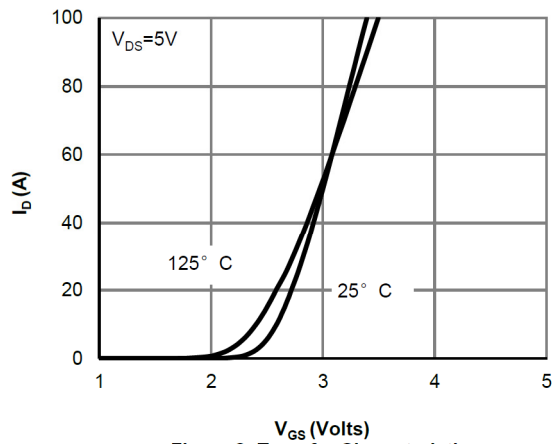

Figure 2: Transfer Characteristics

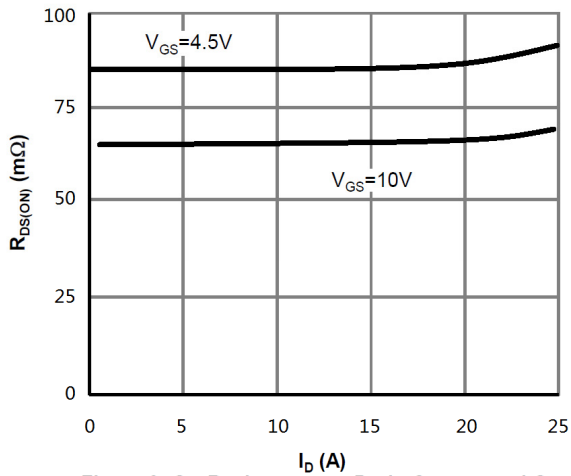

Figure 3: On-Resistance vs. Drain Current and Gate Voltage

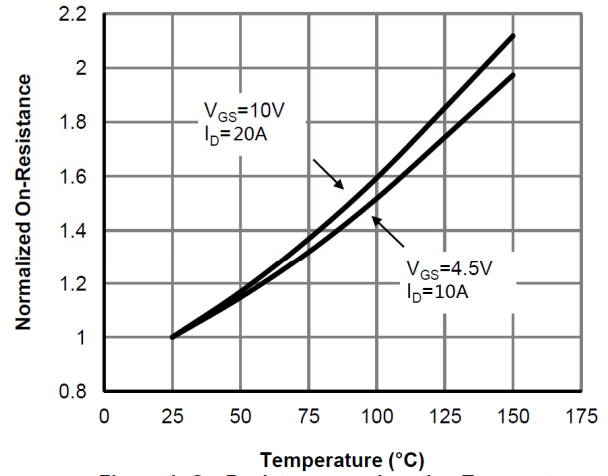

Figure 4: On-Resistance vs. Junction Temperature

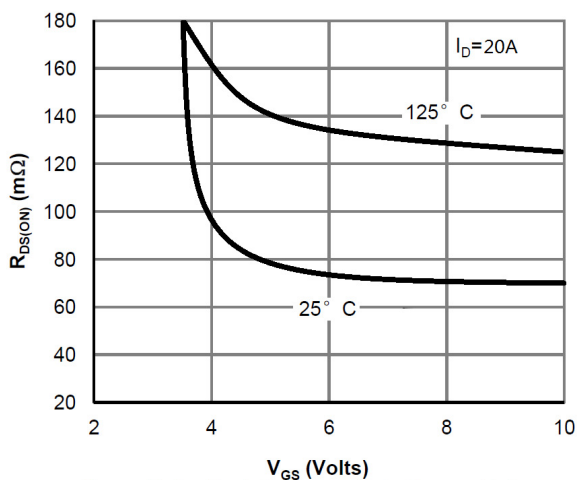

Figure 5: On-Resistance vs. Gate-Source Voltage

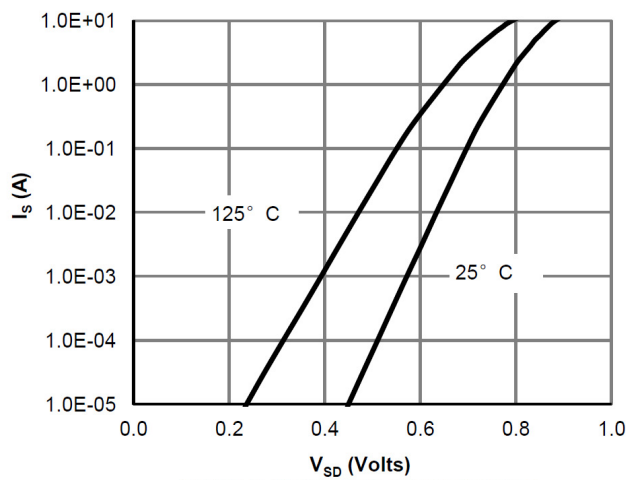

Figure 6: Body-Diode Characteristics

电参数曲线图 / Electrical Characteristic Curve

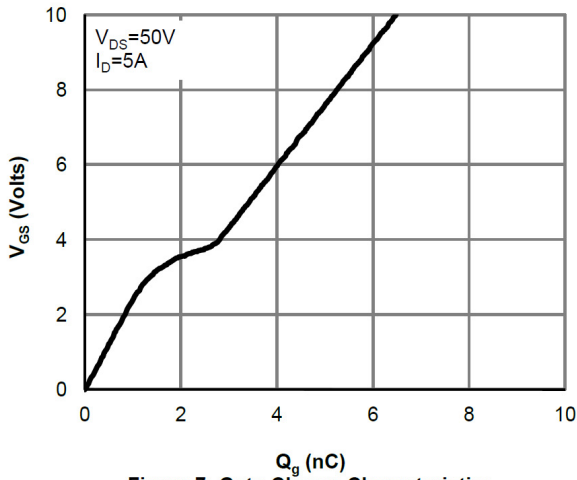

Figure 7: Gate-Charge Characteristics

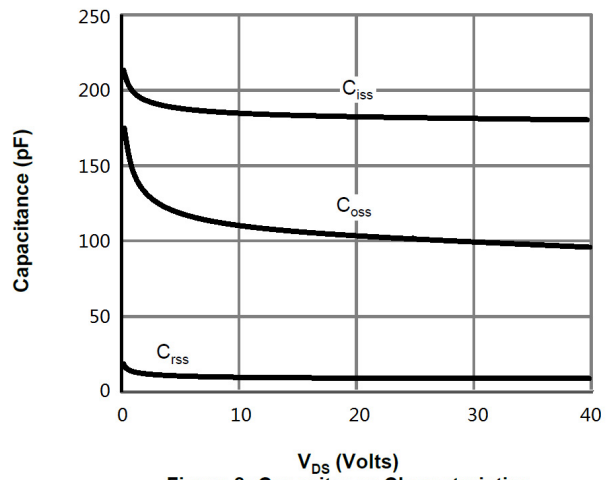

Figure 8: Capacitance Characteristics

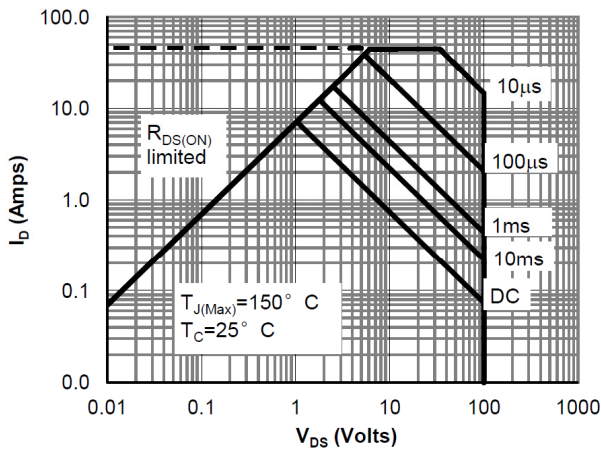

Figure 9: Maximum Forward Biased Safe Operating Area

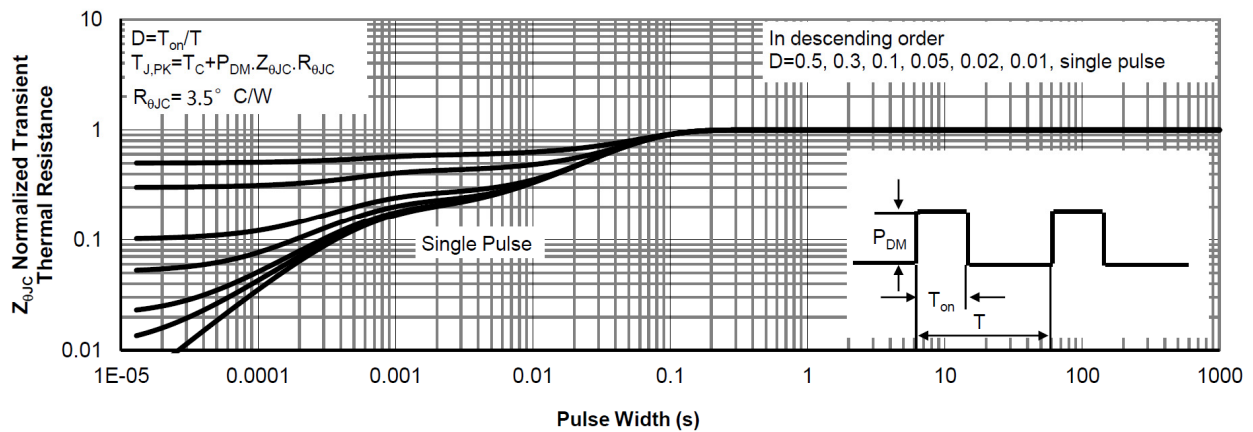

Figure 10: Normalized Maximum Transient Thermal Impedance

BRC900N10SYM

Rev.C Feb.-2023

外形尺寸图 / Package Dimensions

PDFN5 X6A

Unit:mm

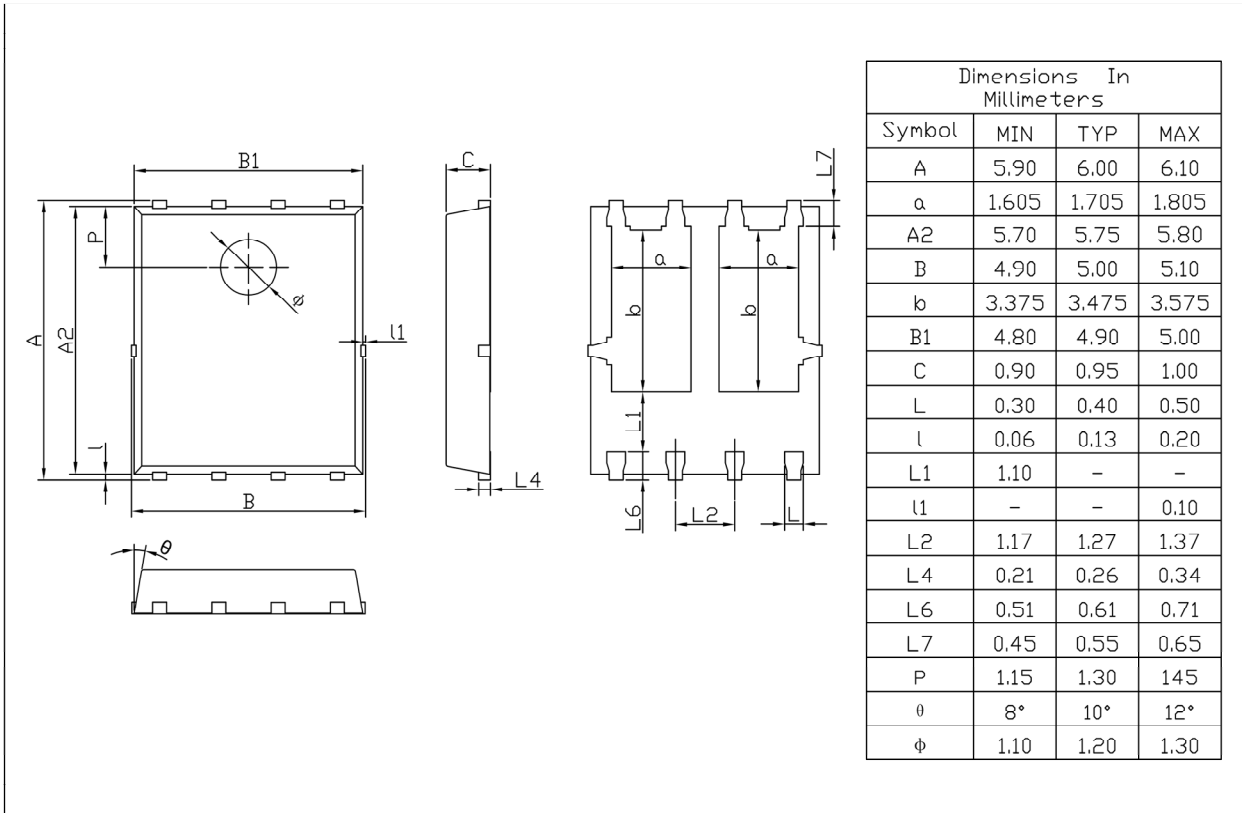

Rev.01 202209

BRC900N10SYM

Rev.C Feb.-2023

印章说明 / Marking Instructions

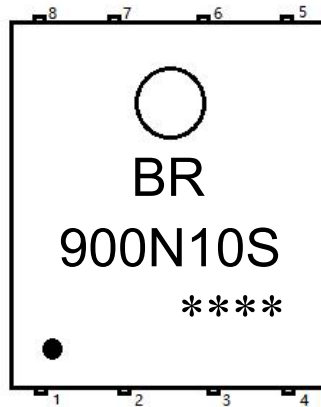

说明：

BR： 为公司代码

900N10S： 为为产品型号

****： 为生产批号代码，随生产批号变化

Note：

BR： Company Code

900N10S： Product Type

****: Lot No. Code, code change with Lot No

回流焊温度曲线图(无铅) / Temperature Profile for IR Reflow Soldering(Pb-Free)

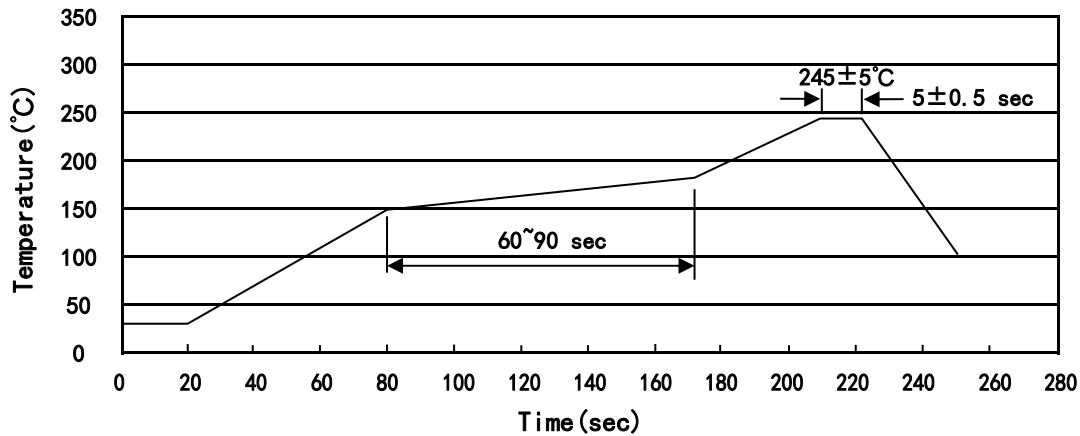

说明：

- 1、预热温度 150~180°C，时间 60~90sec;
- 2、峰值温度 245±5°C，时间持续为 5±0.5sec;
- 3、焊接制程冷却速度为 2~10°C/sec.

Note:

- 1.Preheating:150~180°C, Time:60~90sec.
- 2.Peak Temp.:245±5°C, Duration:5±0.5sec.
3. Cooling Speed: 2~10°C/sec.

耐焊接热试验条件 / Resistance to Soldering Heat Test Conditions

温度：260±5°C

时间：10±1 sec.

Temp.:260±5°C

Time:10±1 sec

包装规格 / Packaging SPEC.

卷盘包装 / REEL

Package Type 封装形式	Units 包装数量					Dimension 包装尺寸 (unit: mm ³)		
	Units/Reel 只/卷盘	Reels/Inner Box 卷盘/盒	Units/Inner Box 只/盒	Inner Boxes/Outer Box 盒/箱	Units/Outer Box 只/箱	Reel	Inner Box 盒	Outer Box 箱
PDFN5×6A	5000	2	10000	6	60000	13"×12	360×360×50	380×335×366

使用说明 / Notices