

BRCS020N04BD

Rev.B Sep.-2022

描述 / Descriptions

TO-263 塑封封装 N 沟道场效应管。
N-CHANNEL MOSFET in a TO-263 Plastic Package.

特征 / Features

低电阻,开关速度快,无卤产品。
Ultra Low On-Resistance,fast switching, HF Product.

用途 / Applications

该器件适用于高效电源模块,主动式 PFC 电路和基于半桥拓扑结构的电子节能灯。
These devices are well suited for high efficient switched mode power supplies, Active power factor correction, electronic lamp ballast based on half bridge topology.

内部等效电路 / Equivalent Circuit

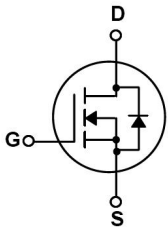

引脚排列 / Pinning

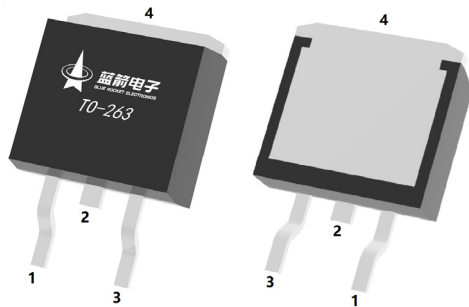

PIN1 : G PIN 2、 4 : D PIN 3 : S

印章代码 / Marking

见印章说明。 See Marking Instructions.

极限参数 / Absolute Maximum Ratings(Ta=25°C)

参数 Parameter	符号 Symbol	数值 Rating	单位 Unit
Drain-Source Voltage	V _{DSS}	40	V
Drain Current	I _D (Tc=25°C)	120	A
Pulsed Drain Current	I _{DM}	480	A
Gate-Source Voltage	V _{GS}	±20	V
Single Pulsed Avalanche Energy L=0.5mH	E _{AS}	482	mJ
Avalanche Current	I _{AS}	35	A
Total Power Dissipation	P _D (Tc=25°C)	187	W
Junction and Storage Temperature Range	T _J , T _{STG}	-55 to 175	°C
Thermal Resistance-Junction to Ambient	t ≤ 10s	15	°C/W
	Steady-State	60	
Thermal Resistance-Junction to Case	Steady-State	0.7	

电性能参数 / Electrical Characteristics(Ta=25°C)

参数 Parameter	符号 Symbol	测试条件 Test Conditions	最小值 Min	典型值 Typ	最大值 Max	单位 Unit
Drain-Source Breakdown Voltage	BV _{DSS}	V _{GS} =0V I _D =250μA	40	44		V
Zero Gate Voltage Drain Current	I _{DSS}	V _{DS} =40V V _{GS} =0V			1	μA
Gate-Body Leakage Current Forward	I _{GSS}	V _{GS} =±20V V _{DS} =0V			±100	nA
Gate Threshold Voltage	V _{GS(th)}	V _{DS} =V _{GS} I _D =250μA	1	1.6	3	V
Static Drain-Source On-Resistance	R _{DS(on)}	V _{GS} =10V I _D =20A		1.6	2	mΩ
		V _{GS} =4.5V I _D =10A		2.1	4	
Forward On Voltage	V _{SD}	V _{GS} =0V I _S =1A			1.2	V
Input Capacitance	C _{iss}	V _{DS} =25V V _{GS} =0V f=1MHz		11000		pF
Output Capacitance	C _{oss}			840		
Reverse Transfer Capacitance	C _{rss}			650		

电性能参数 / Electrical Characteristics(Ta=25°C)

参数 Parameter	符号 Symbol	测试条件 Test Conditions	最小值 Min	典型值 Typ	最大值 Max	单位 Unit
Gate resistance	R _g	f=1MHz		1.45		Ω
Total Gate Charge	Q _g (10V)	V _{GS} =10V V _{DS} =20V I _D =20A		68		nC
Total Gate Charge	Q _g (4.5V)			28		
Gate Source Charge	Q _{gs}			16.5		
Gate Drain Charge	Q _{gd}			4.5		
Turn-On Delay Time	t _{d(on)}	V _{GS} =10V V _{DS} =20V R _L =1Ω R _{GEN} =3Ω		12.5		ns
Turn-On Rise Time	t _r			9.5		
Turn-Off Delay Time	t _{d(off)}			57.5		
Turn-Off Fall Time	t _f			10.5		

电参数曲线图 / Electrical Characteristic Curve

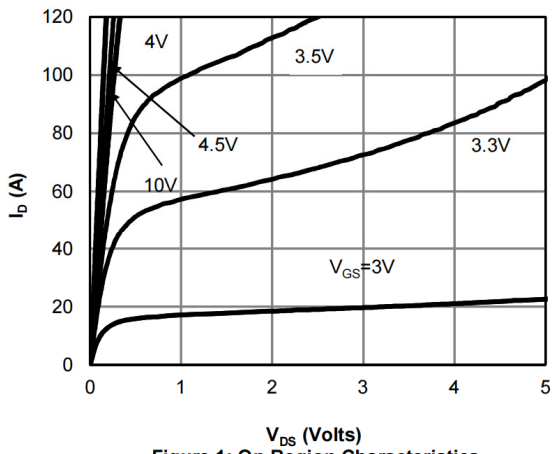

Figure 1: On-Region Characteristics

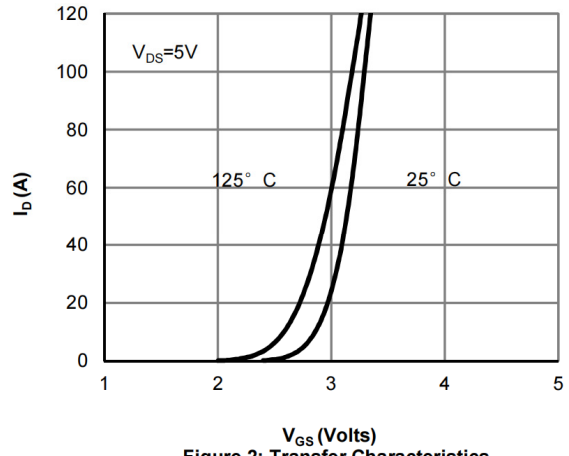

Figure 2: Transfer Characteristics

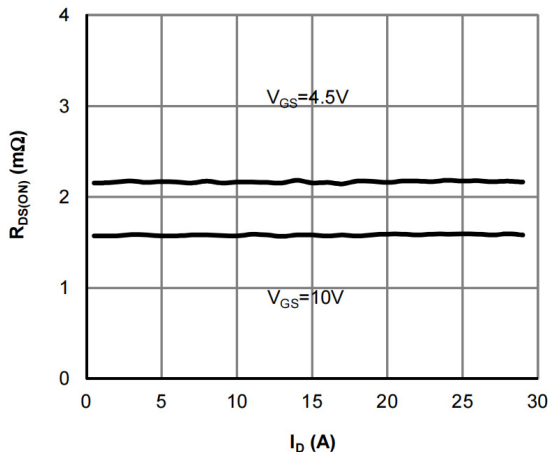

Figure 3: On-Resistance vs. Drain Current and Gate Voltage

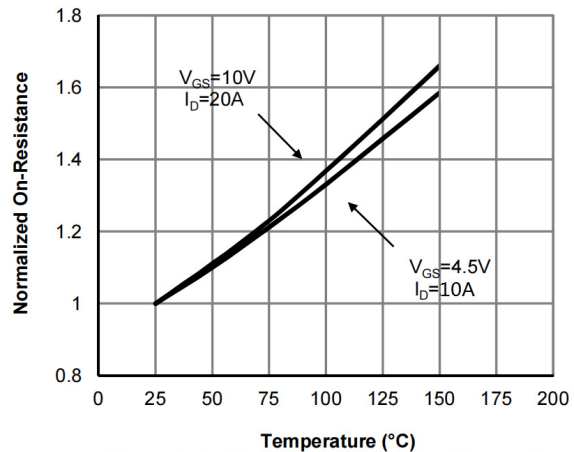

Figure 4: On-Resistance vs. Junction Temperature

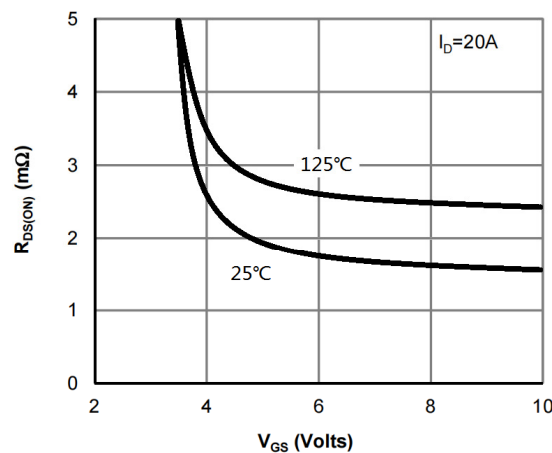

Figure 5: On-Resistance vs. Gate-Source Voltage

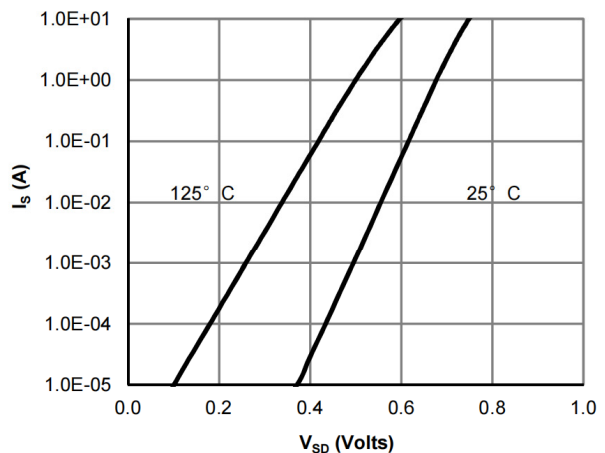

Figure 6: Body-Diode Characteristics

电参数曲线图 / Electrical Characteristic Curve

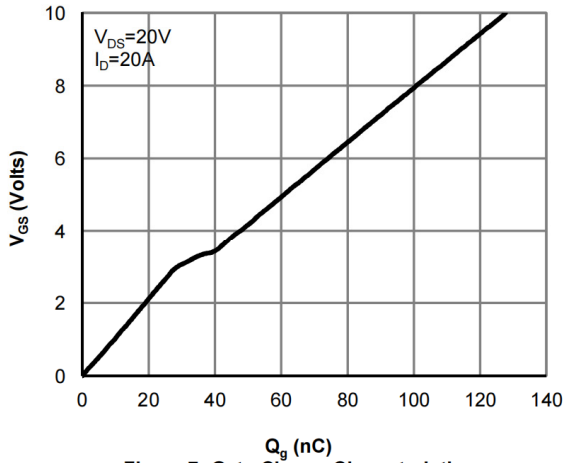

Figure 7: Gate-Charge Characteristics

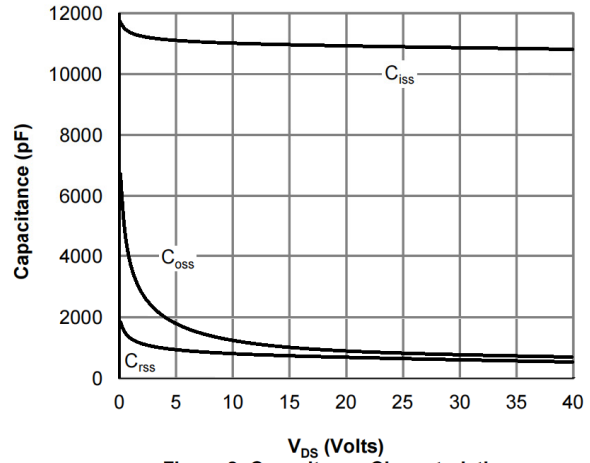

Figure 8: Capacitance Characteristics

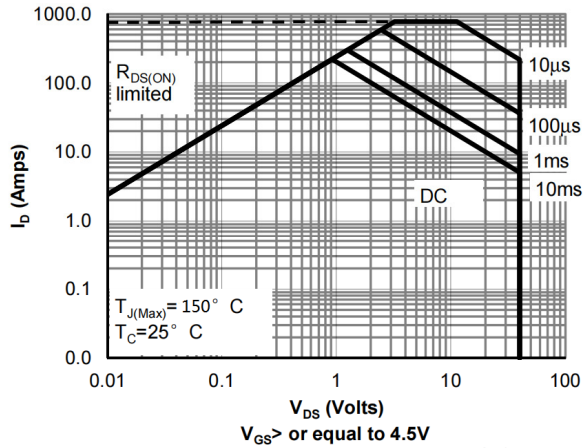

Figure 9: Maximum Forward Biased Safe Operating Area

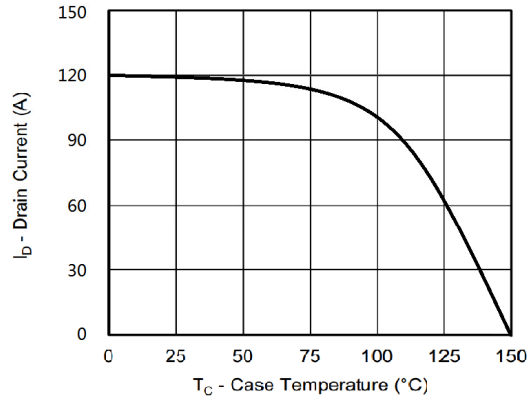

Figure 10: Maximum Continuous Drain Current vs Case Temperature

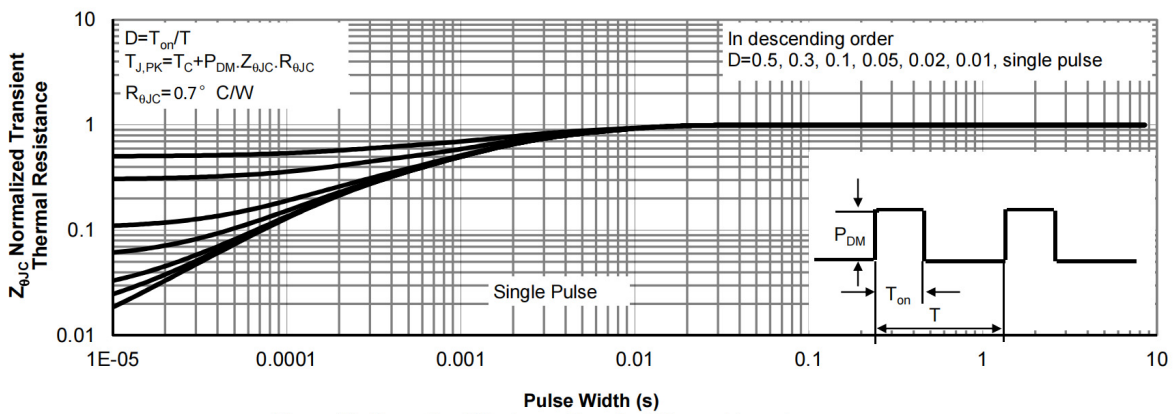
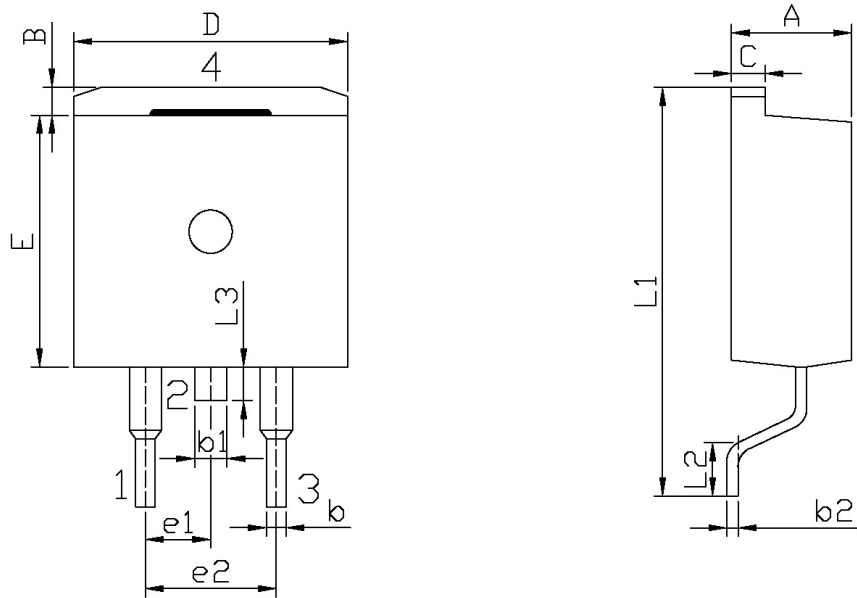

Figure 11: Normalized Maximum Transient Thermal Impedance

外形尺寸图 / Package Dimensions



单位: mm

Symbol	Dimensions In Millimeters		Symbol	Dimensions In Millimeters	
	Min	Max		Min	Max
A	4.30	4.70	E	9.00	9.40
B	1.00	1.40	e1	2.34	2.74
b	0.70	0.90	e2	4.88	5.28
b1	1.15	1.35	L1	15.00	16.00
b2	0.40	0.60	L2	2.24	2.84
C	1.20	1.40	L3	1.20	1.60
D	9.80	10.20			

T0-263

印章说明 / Marking Instructions

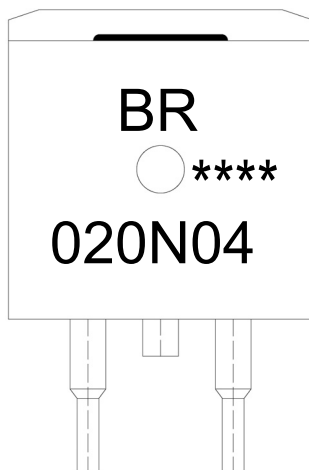

说明：

BR： 为公司代码

020N04： 为型号代码

****： 为生产批号代码，随生产批号变化

Note:

BR: Company Code

020N04: Product Type

****: Lot No. Code, code change with Lot No

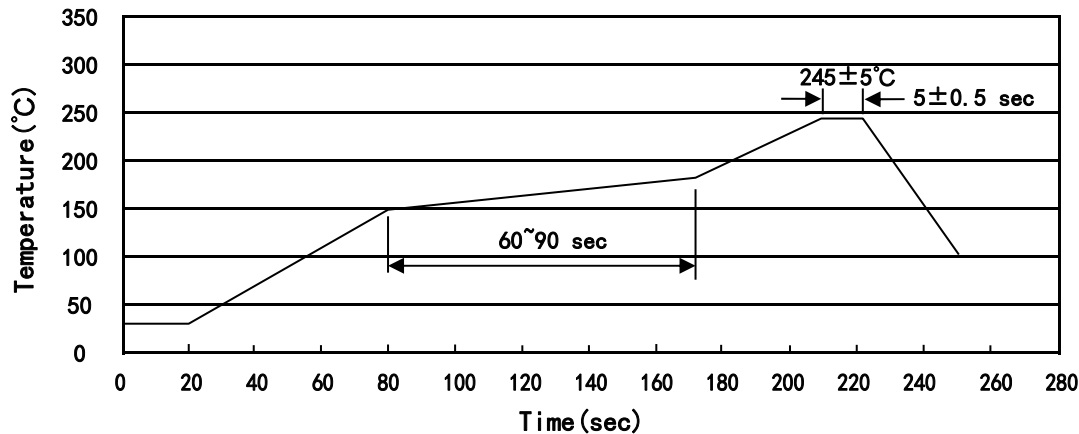
回流焊温度曲线图(无铅) / Temperature Profile for IR Reflow Soldering(Pb-Free)

说明：

- 1、预热温度 150~180°C，时间 60~90sec;
- 2、峰值温度 245±5°C，时间持续为 5±0.5sec;
- 3、焊接制程冷却速度为 2~10°C/sec.

Note:

- 1.Preheating:150~180°C, Time:60~90sec.
- 2.Peak Temp.:245±5°C, Duration:5±0.5sec.
3. Cooling Speed: 2~10°C/sec.

耐焊接热试验条件 / Resistance to Soldering Heat Test Conditions

温度：260±5°C

时间：10±1 sec.

Temp.:260±5°C

Time:10±1 sec

包装规格 / Packaging SPEC.

卷盘包装 / REEL

Package Type 封装形式	Units 包装数量					Dimension 包装尺寸 (unit: mm ³)		
	Units/Reel 只/卷盘	Reels/Inner Box 卷盘/盒	Units/Inner Box 只/盒	Inner Boxes/Outer Box 盒/箱	Units/Outer Box 只/箱	Reel	Inner Box 盒	Outer Box 箱
TO-263	800	1	800	6	4,800	13" ×24	360×360×50	380×335×366

套管包装 / TUBE

Package Type 封装形式	Units 包装数量					Dimension 包装尺寸 (unit: mm ³)		
	Units/Tube 只/套管	Tubes/Inner Box 套管/盒	Units/Inner Box 只/盒	Inner Boxes/Outer Box 盒/箱	Units/Outer Box 只/箱	Tube 套管	Inner Box 盒	Outer Box 箱
TO-263	50	20	1,000	5	5,000	532×33×7.0	555×164×50	575×290×180

使用说明 / Notices