

描述 / Descriptions

TO-3P 塑封封装 NPN 半导体三极管。Silicon NPN transistor in a TO-3P Plastic Package.

特征 / Features

耐压高。
High voltage.

用途 / Applications

用于加湿器，直流-直流转换器和一般用途。
Humidifier, DC-DC converter, and general purpose.

内部等效电路 / Equivalent Circuit

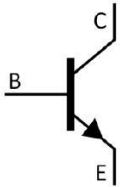

引脚排列 / Pinning

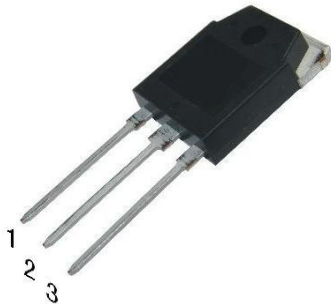

PIN1 : Base PIN 2 : Collector PIN 3 : Emitter

放大及印章代码 / h_{FE} Classifications & Marking

见印章说明。See Marking Instructions.

极限参数 / Absolute Maximum Ratings(Ta=25°C)

参数 Parameter	符号 Symbol	数值 Rating	单位 Unit
Collector to Base Voltage	V_{CBO}	200	V
Collector to Emitter Voltage	V_{CEO}	120	V
Emitter to Base Voltage	V_{EBO}	8.0	V
Collector Current - Continuous	I_C	7.0	A
Base Current	I_B	3.0	A
Collector Power Dissipation	$P_C (T_C=25^\circ C)$	70	W
Junction Temperature	T_j	150	°C
Storage Temperature Range	T_{stg}	-55~150	°C

电性能参数 / Electrical Characteristics(Ta=25°C)

参数 Parameter	符号 Symbol	测试条件 Test Conditions	最小值 Min	典型值 Typ	最大值 Max	单位 Unit
Collector to Emitter Breakdown Voltage	V_{CEO}	$I_C=50mA$ $I_E=0$	120			V
Collector Cut-Off Current	I_{CBO}	$V_{CB}=200V$ $I_E=0$			100	μA
Emitter Cut-Off Current	I_{EBO}	$V_{EB}=8.0V$ $I_E=0$			100	μA
DC Current Gain	h_{FE}	$V_{CE}=4.0V$ $I_C=3.0A$	70		220	
Collector to Emitter Saturation Voltage	$V_{CE(sat)}$	$I_C=3.0A$ $I_B=0.3A$			0.5	V
Base to Emitter Saturation Voltage	$V_{BE(sat)}$	$I_C=3.0A$ $I_B=0.3A$			1.2	V
Transition Frequency	f_T	$V_{CE}=12V$ $I_E=-0.5A$		30		MHz
Collector Output Capacitance	C_{ob}	$f=1.0MHz$ $V_{CB}=10V$		110		pF

电参数曲线图 / Electrical Characteristic Curve

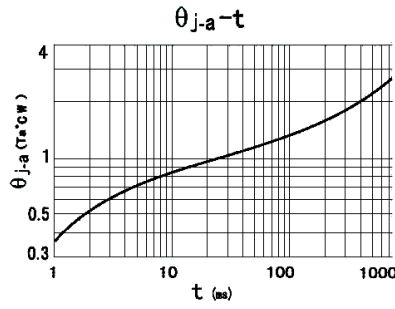
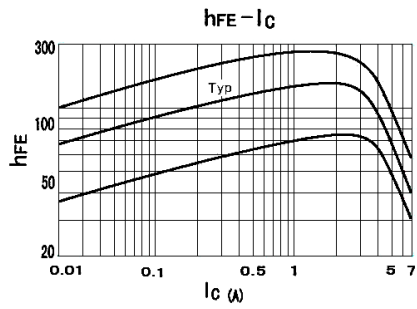
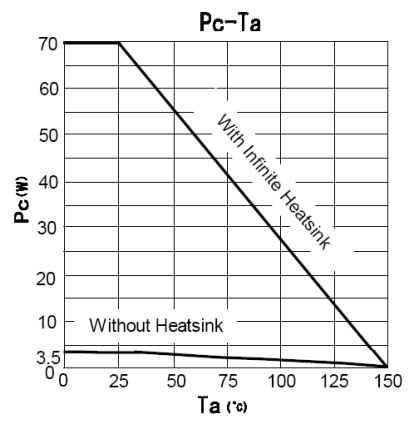
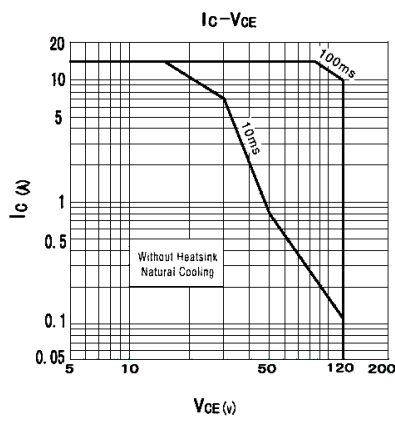
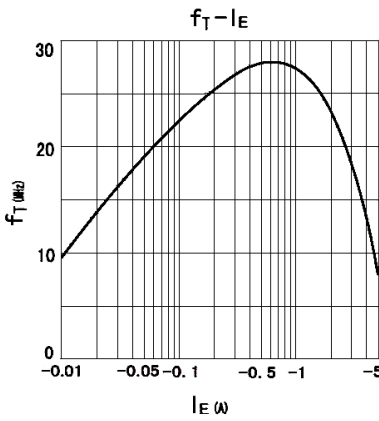
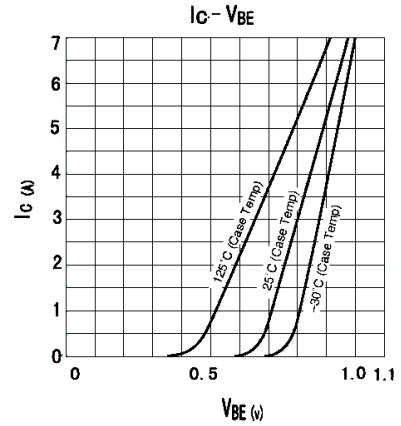
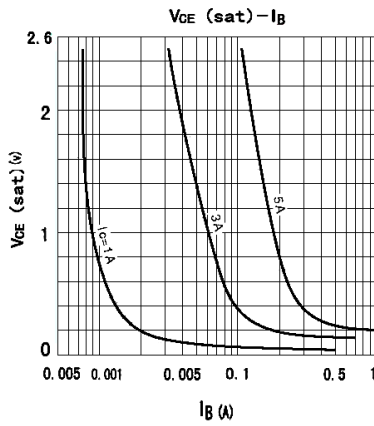
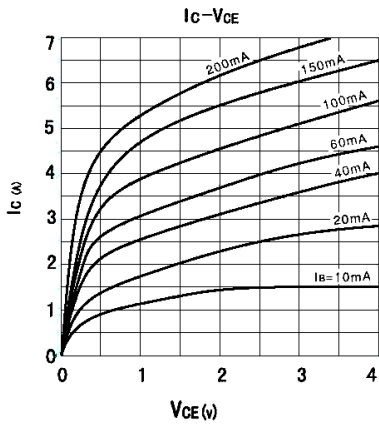

外形尺寸图 / Package Dimensions

TO-3P

单位: mm

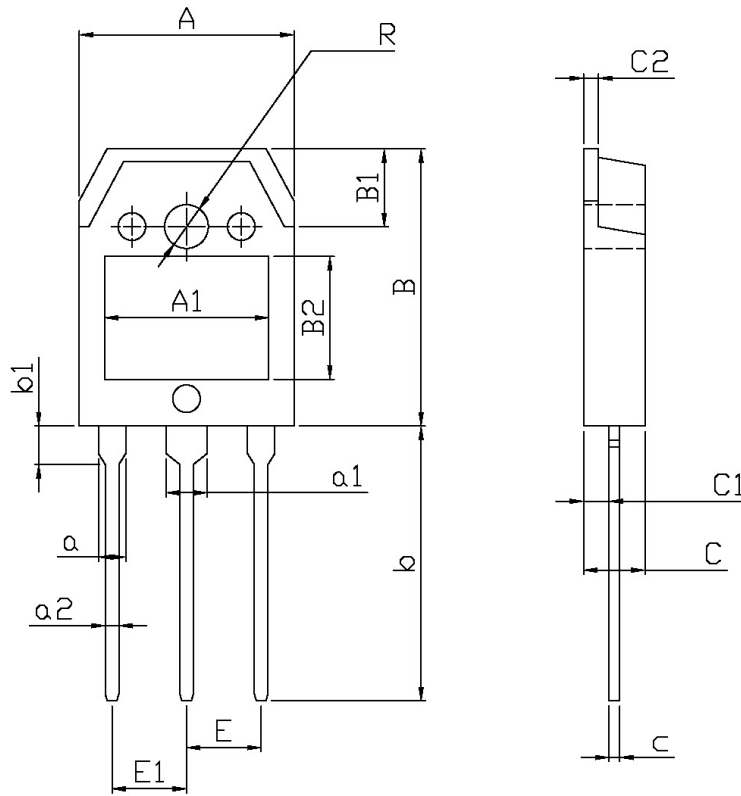

Symbol	Dimensions In Millimeters		Symbol	Dimensions In Millimeters	
	Min	Max		Min	Max
A	15.4	16.0	a2	0.8	1.2
R	3.1	3.5	E	5.45	
B	19.8	20.8	E1	5.45	
B1	5.5	5.9	C	4.3	4.7
B2	9.0		C1	1.2	1.6
A1	12.0		C2	1.4	1.6
b	19.6	20.6	c	0.5	0.7
b1	3.0	3.4			
a	1.8	2.2			
a1	2.8	3.2			

印章说明 / Marking Instructions

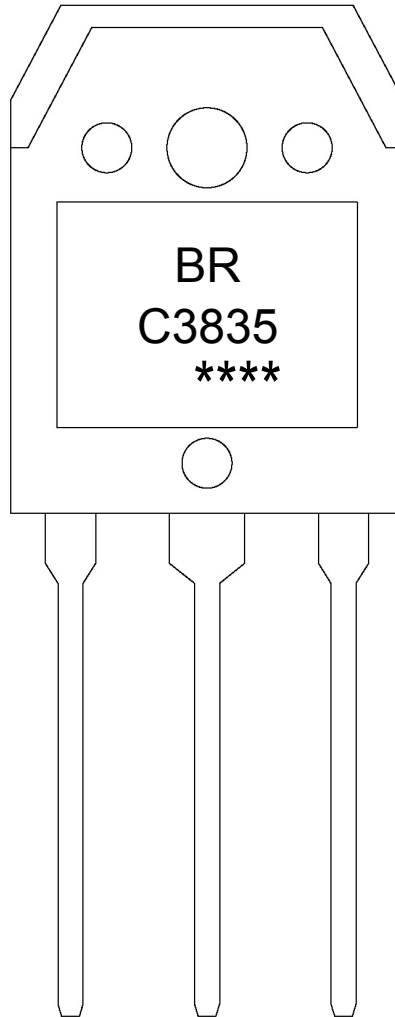

说明：

BR: 为公司代码

C3835 : 为型号代码

**** : 为生产批号代码，随生产批号变化。

Note:

BR: Company Code.

C3835: Product Type.

****: Lot No. Code, code change with Lot No.

波峰焊温度曲线图(无铅) / Temperature Profile for Dip Soldering(Pb-Free)

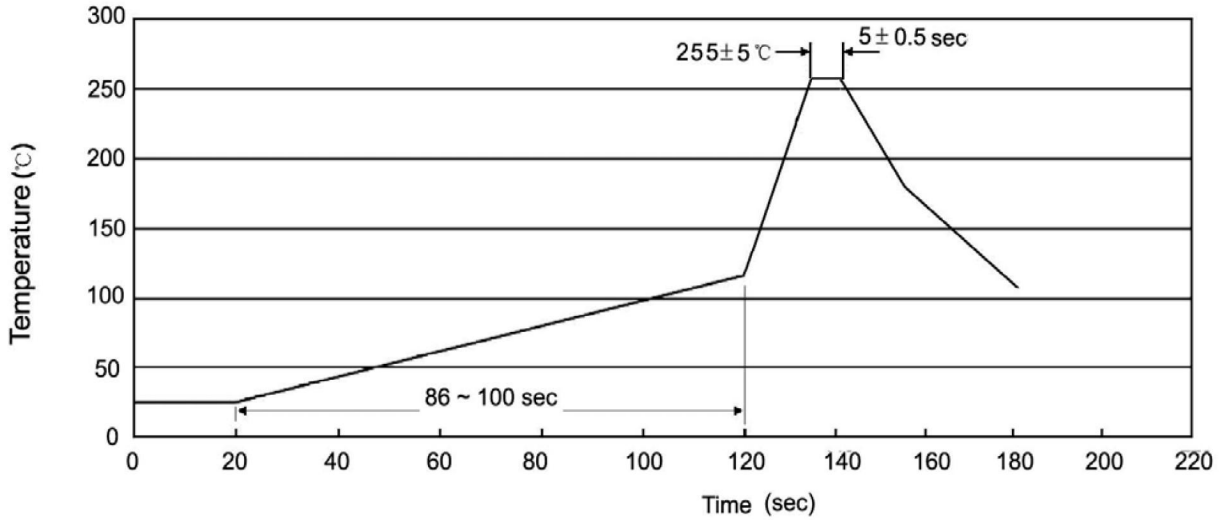

说明：

- 1、预热温度 25~150°C，时间 60~90sec;
- 2、峰值温度 255±5°C，时间持续为 5±0.5sec;
- 3、焊接制程冷却速度为 2~10°C/sec.

Note:

- 1.Preheating:25~150°C, Time:60~90sec.
- 2.Peak Temp.:255±5°C, Duration:5±0.5sec.
3. Cooling Speed: 2~10°C/sec.

耐焊接热试验条件 / Resistance to Soldering Heat Test Conditions

温度：270±5°C 时间：10±1 sec. Temp.:270±5°C Time:10±1 sec

包装规格 / Packaging SPEC.

套管包装 / TUBE

Package Type 封装形式	Units 包装数量					Dimension 包装尺寸 (unit: mm ³)		
	Units/Tube 只/套管	Tubes/Inner Box 套管/盒	Units/Inner Box 只/盒	Inner Boxes/Outer Box 盒/箱	Units/Outer Box 只/箱	Tube 套管	Inner Box 盒	Outer Box 箱
TO-3P	30	15	450	5	2250	497.5×46×8	555×164×50	575×290×180

使用说明 / Notices